

## TECHNICAL DATA



### TYPE

DOMINO flood sports light is a versatile, modular system that ranges from 600W to 900W, with a single mode option of 300W. It has a high light efficiency of 150 lumens per watt and durable components made of aluminum alloy. The lenses are made of PC material for high transmittance and are protected by toughened glass.

### CHARACTERISTICS

Chip: Lumileds 2835 70Ra

Nomial efficacy: 150Lm/W

Maximum LED: 1000mA

Lifetime L90B10:>100,000 hours

Luminous flux and efficacy at 5700°K and CRI>90

Luminous flux tolerance <+/-3%

Values may be subject to change du LED binning.

### OPENING/BEAM

High efficiency Ra>80 LED. 90°

### MATERIAL

Die-casting/High Thermal Conductivity AL

Finish: Powder coated Aluminum

Lens: Glass+Polycarbonate

Color: Black



<b>Model:</b>	Domino
<b>Format:</b>	Rectangular
<b>Location:</b>	Exterior
<b>Wattage:</b>	900W
<b>Materials:</b>	Aluminium
<b>Led Color:</b>	5700K
<b>Product Dimension:</b>	610*318*651mm
<b>IP Code:</b>	66
<b>Fixation:</b>	Surface
<b>CRI :</b>	90
<b>Lumen Output:</b>	135000LM
<b>Frequency:</b>	50/60 Hz
<b>Beam Angle:</b>	90°
<b>Weight:</b>	23 Kgs

## DIMENSION DRAW

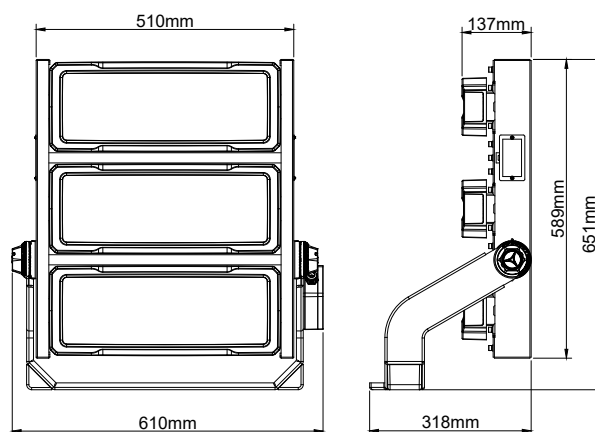

# OUTDOOR

## VISOR OPTIONAL



## APPLICATIONS

**Outdoor / Indoor / Industrial**

- Parking lots and garages
- Security and outdoor surveillance
- Industrial and construction sites
- Large-scale outdoor events
- Sports & recreational fields

**OUTDOOR**